

Navodila za uporabo

Priporočljivo je, da ob nakupu razpakiranega izdelka v trgovini preverite njegovo kakovost in popolnost. Izdelek je treba sestaviti tako, kot je opisano v tem priročniku.

Medtem ko je izdelek v uporabi, je treba občasno zategniti ohlapne vijačne spoje.

Če je treba premikati predmete, po stanovanju, morate pred premikanjem izdelek popolnoma sprostiti z bremena (ležišča). Da bi preprečili poškodbe obstoječih nosilcev, je treba izdelek pred premikanjem dvigniti. Pohištvo ne sme biti izpostavljeno stiku z vodo.

Brisanje prahu na izdelku je treba opraviti z rahlo vlažno mehko krpo.

Da bi preprečili deformacijo delov in spremembo barve izdelkov, pohištva ne nameščajte na neposredno sončno svetlobo.

Medtem ko je izdelek v uporabi, je **PREPOVEDANO**:

- nameščati pohištvo v bližini grelnih naprav, blizu surovih sten in v prostorih z relativno vlažnostjo več kot 70 %;
- segrevati elementov pohištva na temperaturo, višjo od 40 C;
- med sestavljanjem in uporabo kompleta izdelkov stopati na vodoravne ščite in okna;
- uporabljati kemičnih čistil za čiščenje pohištva.

Garancija proizvajalca







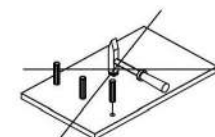
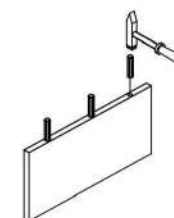
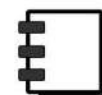
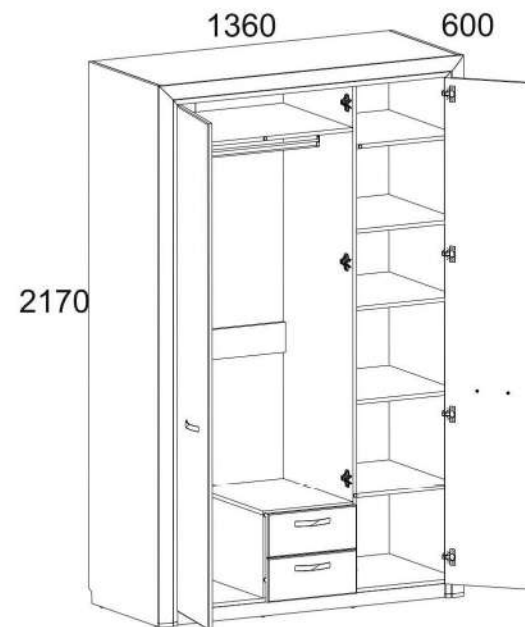





















1. Garancijski rok za uporabo izdelka - 24 mesecev od datuma prodaje. V garancijskem roku proizvajalec zagotavlja popravilo ali zamenjavo izdelkov, če uporabnik ni kršil pravil uporabe.
2. Reklamacije mora potrošnik vložiti neposredno pri trgovski organizaciji, v kateri je bilo pohištvo kupljeno, pri čemer mora predložiti "Navodila za uporabo " in kopijo potrdila o prodaji.
3. Izdelek, ki je del kompleta, izpolnjuje zahteve državni standardi 16371-93, TR TS 025/2012.
4. Življenjska doba pohištva - 10 let.
5. Proizvajalec si pridržuje pravico do sprememb v zasnovi izdelka, ne da bi pri tem ogrozil njegove zahteve glede zasnove in uporabe.
6. Za sestavljanje izdelkov je priporočljivo vključiti usposobljeno osebje.

To je pomembno! Navodila shranite za primer ponovne montaže pohištva ali reklamacije. Pri uveljavljanju reklamacije uporabite zapis iz navodila.

OTILIA 3D2S

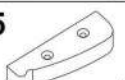

Nº	DOLŽINA MM.	ŠIRINA MM.	GLOBINA MM.		PAKET
1	1323	575	16	1	2/5
2	1323	575	16	1	2/5
3	452	575	16	4	1/5
4	454	575	16	1	2/5
5	1323	55	16	2	2/5
6	2166	575	16	1	3/5
7	2166	575	16	1	3/5
8	2152	80	25	1	5/5
9	2152	80	25	1	5/5
10	400	575	16	1	1/5
11	2028	396	18	1	4/5
12	2028	396	18	1	4/5
13	332	575	16	1	1/5
14	2079	575	16	1	3/5
15	1358	80	25	1	5/5
16	500	100	18	2	2/5
17	500	100	18	2	2/5
19	853	575	16	1	2/5
20	853	120	16	1	2/5
23	506	355	2,5	2	1/5
24	2104	875	2,5	1	3/5
25	2104	475	2,5	1	3/5
30	396	175	18	2	4/5
50	321	100	18	2	2/5
Y	847			1	2/5

A1  52	A2  56	A9  2	C1  8x35 63	S5  22
N1  8	M12  M4x25 8	H19  4	S6  1	B5  1
R24  7x50 8	I  1	G  1,5x26 56	Z13  450 2	R27  5,0x13 28
E1  3	E2  8	D1  11	R23  6,3x13 22	Ri2  3,5x16 30
Y1  2	S3  7	R3  3x20 27	R5  3x30 4	V5  2
P1  16	Q  6	S8  8		

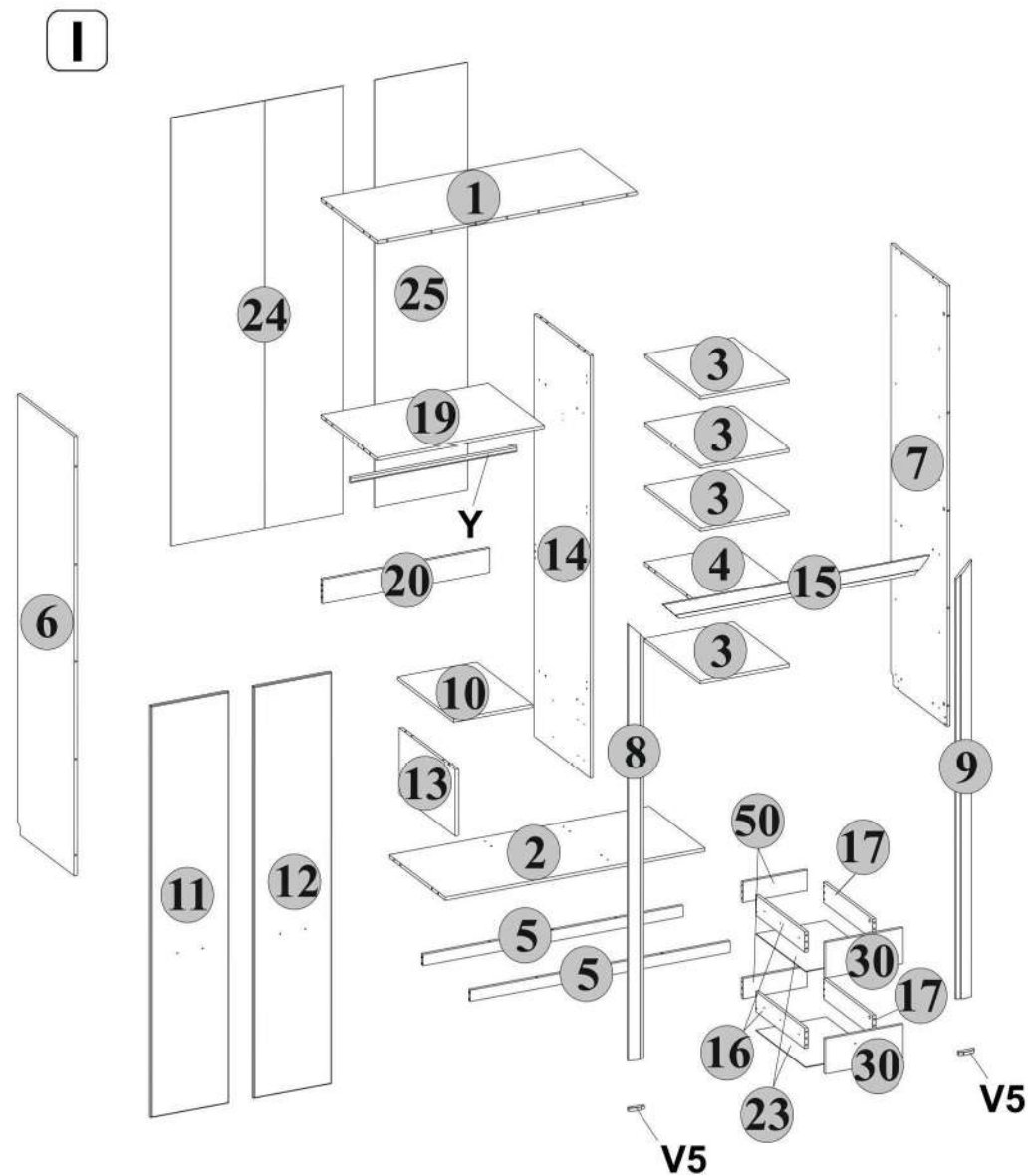

II

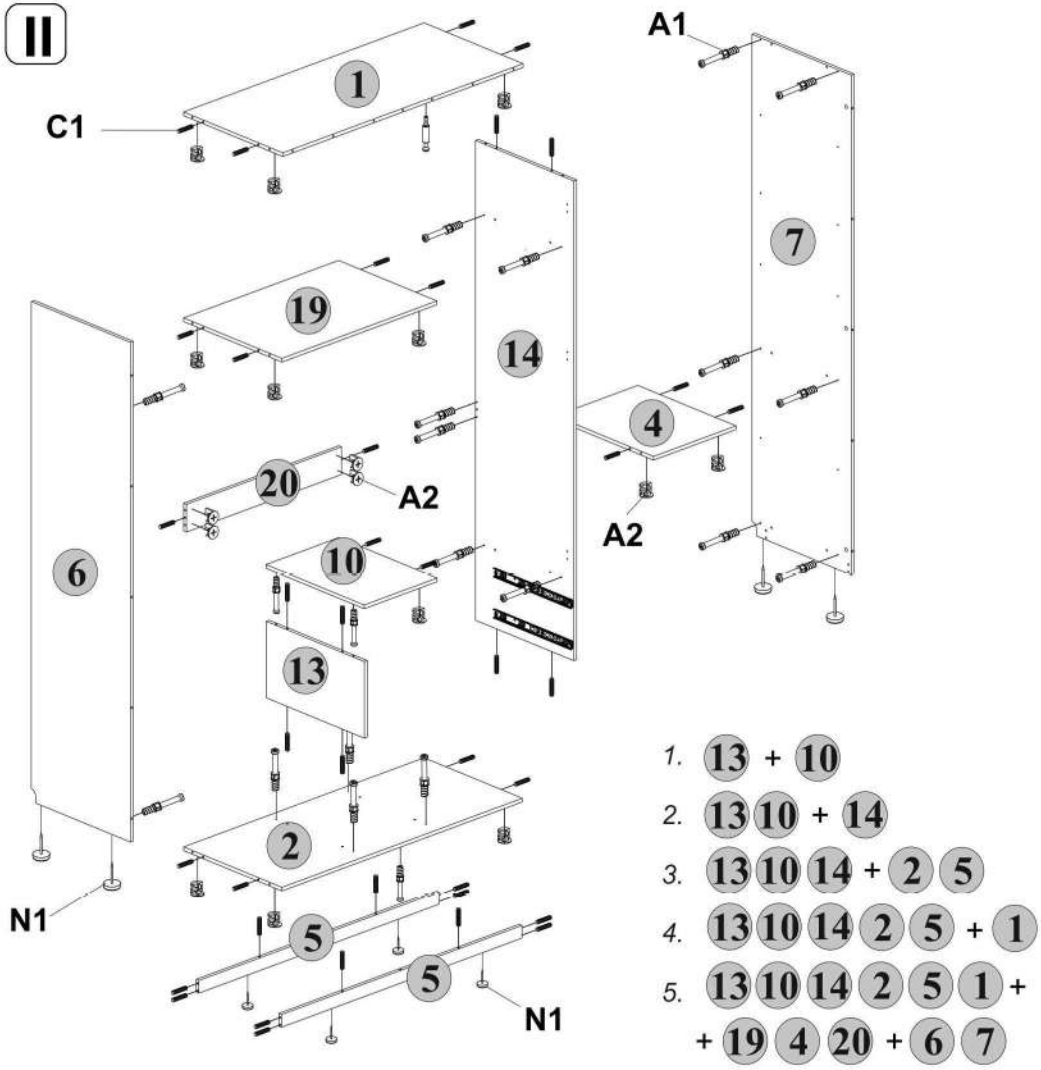

1. 13 + 10
2. 13 10 + 14
3. 13 10 14 + 2 5
4. 13 10 14 2 5 + 1
5. 13 10 14 2 5 1 +
+ 19 4 20 + 6 7

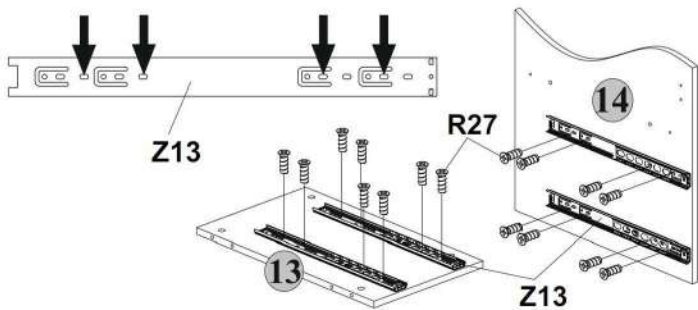

III

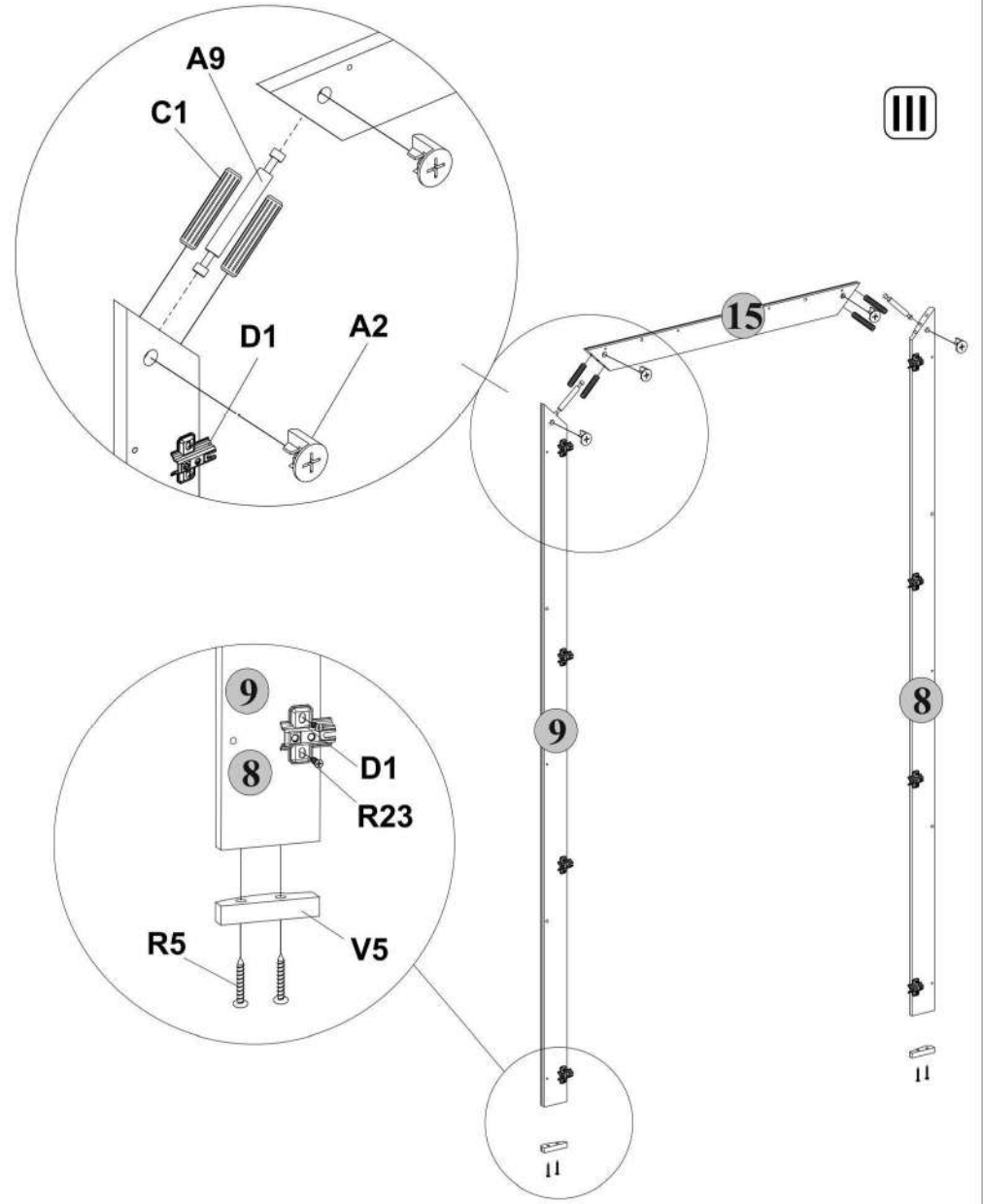

11

